

# SOLAR KING LIGHT 3.0



**BCT-OLK3.0**

Patent Number: ZL2021 3 0095120.5



Light energy charging



Always bright on rainy days



Wide lighting range



Clean Energy

## ► Product Parameters

\*Battery may be stored up to 3 months then a freshening charge is required.

Product name	80W King Light 3.0	120W King Light 3.0
Model	BCT-OLK3.0-A	BCT-OLK3.0-B
Solar panel	160W (Mono)	180W (Mono)
Panel size	680×1134×30×25 mm	730×1134×30×25 mm
Battery	3.2V/160(±5)Ah LiFePO4 Battery	3.2V/200(±5)Ah LiFePO4 Battery
Light power	8400lm (Common 80W LED)	14000lm (Common 120W LED)
Lighting time	6+X/Intelligent power control, and can use remote control to adjust brightness and working mode.	
Installation height	8-10m	10-12m
Installation distance	40-50m	40-50m
Gross weight	22.6kg	22.7kg
Lamp life	100000 hours	
Installation diameter	φ60(±3) mm	
Lamp size	848×288×128mm	
Lamp carton size	915×355×150mm (1 pc/carton)	
Solar panel carton size	1150×695×140mm (4 pcs/carton)	1150×745×140mm (4 pcs/carton)
Beam angle	bat wing 150°70°	
CRI	Ra70	
Color temperature	6500K,4000K	
IP rating	IP65	
IK level	IK08	
Operating temperature	-40°C~70°C	
Working humidity	10%~90%	

\*Note: The above data are typical values. The actual product weight will have an error of about 5%.

## Product Display

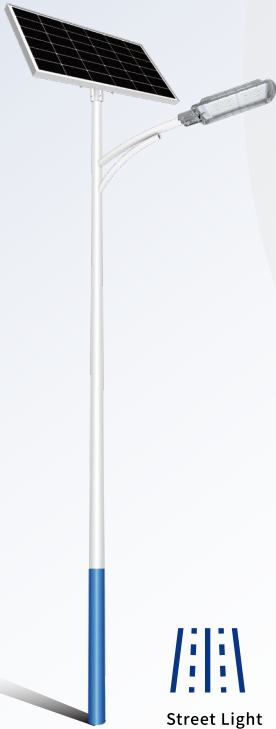

  
Street Light



### ► Product Size:

#### • Lamp head size chart

Unit:mm

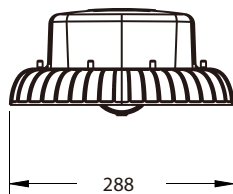
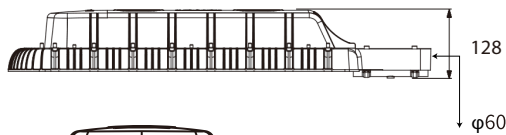
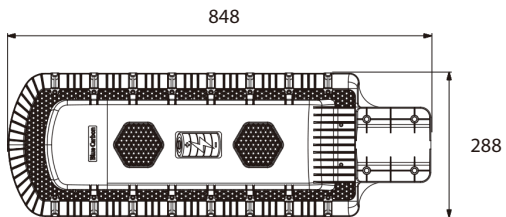

#### • Solar panel size chart

■ 680×1134×30×25 mm

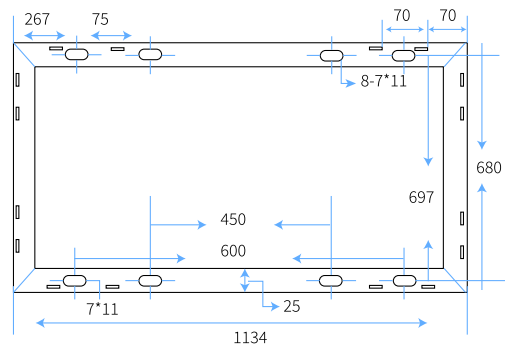

■ 730×1134×30×25 mm

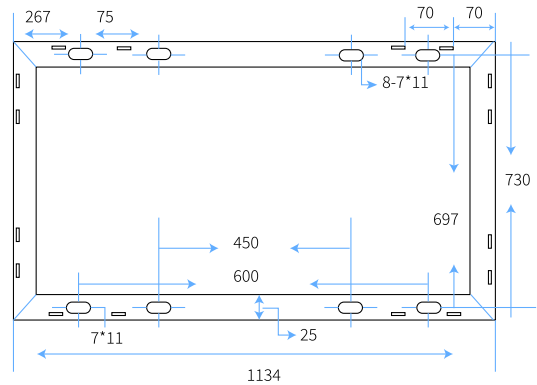

## ► Product Details Display

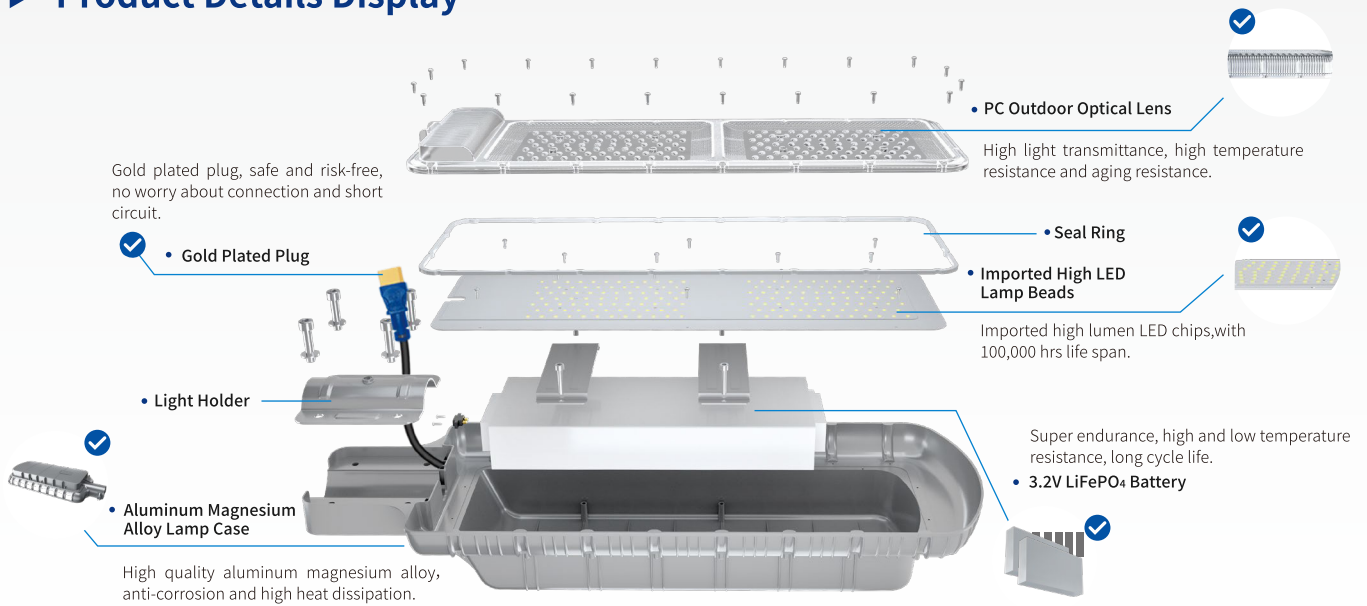

- Original patent design, independent mould.
- All night lighting. The light never be off no matter how many rainy or cloudy days.
- The light can be installed from Equator area to Polar regions. The working temperature is -47-70°C
- Integrated design, modular production.
- Low voltage design, safe and Reliable.
- Integrated package, convenient transportation.

## ► IES

BCT-OLK3.0-A

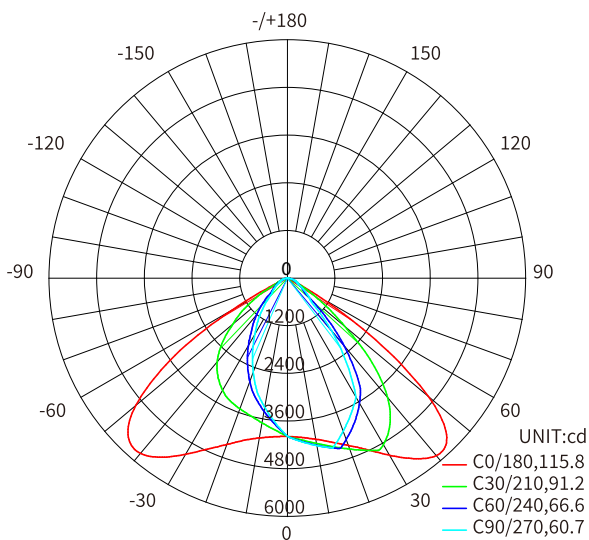

BCT-OLK3.0-B

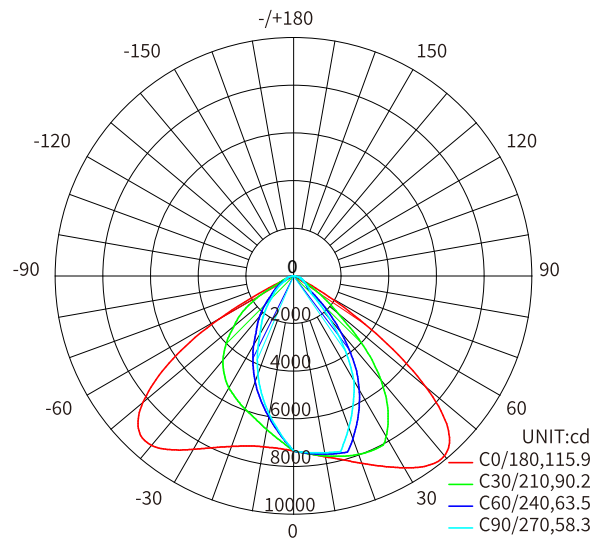

## ► Installation Case

### Applicable place:

It is widely used in streets and roads, residential areas, scenic spots, parks, squares, private gardens and other public places.

The product is easy to install, no auxiliary lines required, energy saving and environmental protection, no electricity charge, long service life.

## Solar King Light 3.0



▲ Hebei, China



▲ Shanxi, China



▲ Iraq

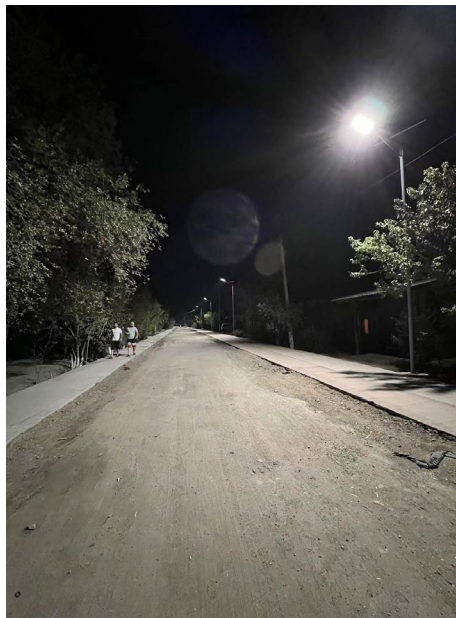

▲ Uzbekistan

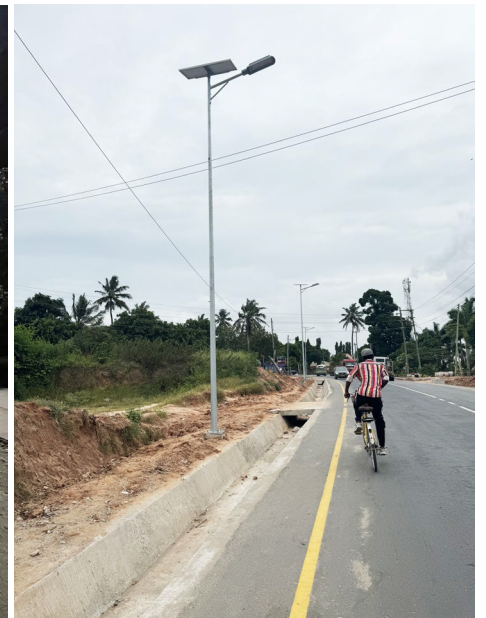

▲ Nigeria



▲ Shenyang, China



▲ Shandong, China



▲ Cambodia



▲ Iraq